

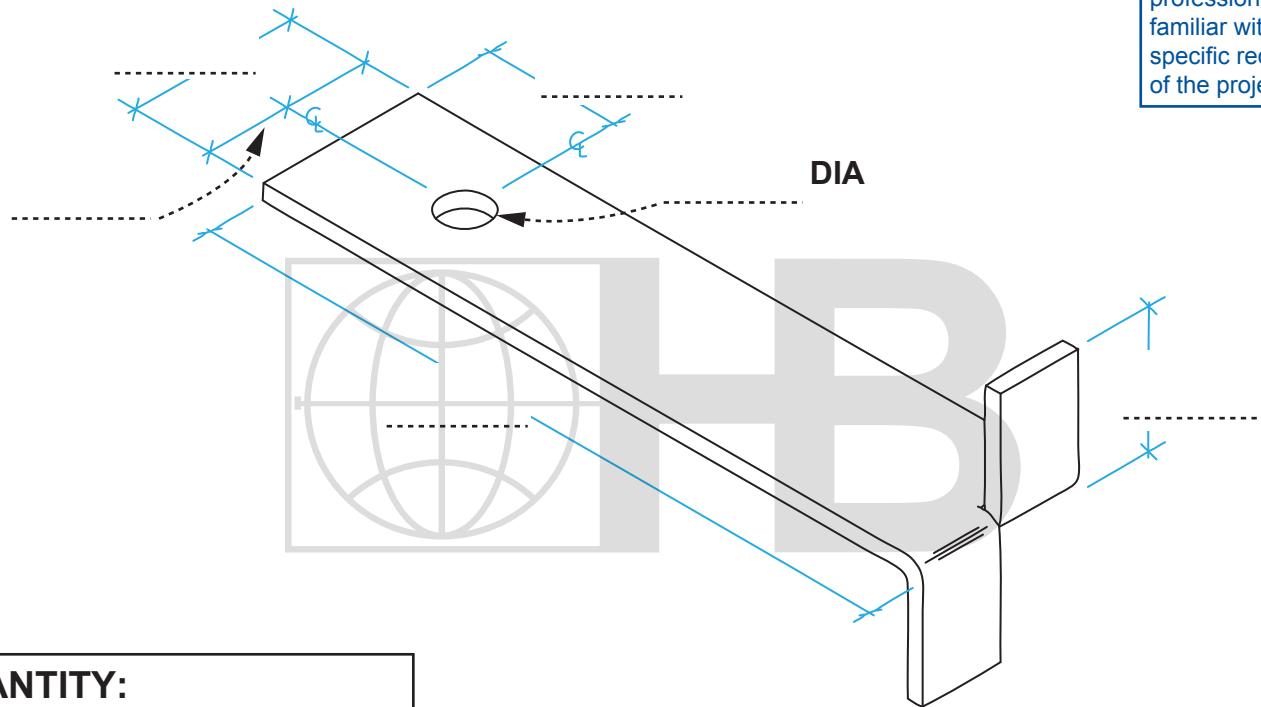

STAINLESS STEEL STONE ANCHORS #439 STONE ANCHOR

The appropriate selection and use of any product contained herein must be determined by competent architects, engineers and other professionals who are familiar with the specific requirements of the project.



QUANTITY:

ST/ST Plate Min. Fy. = 45,000 p.s.i. (ASTM A666)

DRAWINGS FOR ILLUSTRATIVE PURPOSES ONLY

FINISH:		THICKNESS:		
<input type="checkbox"/> TYPE 304 Stainless Steel	<input type="checkbox"/> TYPE 316 Stainless Steel	<input type="checkbox"/> 12 ga./2.78 mm	<input type="checkbox"/> 3/16"/4.7 mm	<input type="checkbox"/> 3/8"/9.5 mm
<input type="checkbox"/>	<input type="checkbox"/>	<input type="checkbox"/> 1/8"/3.2 mm	<input type="checkbox"/> 1/4"/6.3 mm	<input type="checkbox"/> OTHER _____

H&B recommends the exclusive use of 304 or 316 Stainless Steel for stone anchorage.

PROJECT NAME:	CONTACT INFO
LOCATION:	Name :
NOTES:	Company:
	Phone: FAX:
	Email:

Due to fabrication requirements and lead times, once a custom anchor order has been scheduled it cannot be cancelled and will not be returnable. Verify all measurements before signing this form. Any changes after the initial order is placed will require a new signed form, and an additional charge. By signing this document, you agree to the terms stated above and accept full responsibility for the accuracy of measurements.

Orders without a signature will not be processed.

ACCEPTED BY: _____

DATE: _____

HOHMANN & BARNARD, Inc.
30 Rasons Court | Hauppauge, NY 11788
CORPORATE HEADQUARTERS
T: 800.645.0616 F: 631.234.0683
www.h-b.com

Branch/Subsidiary Locations:
ALABAMA - ARIZONA - ILLINOIS
MARYLAND - NEW YORK - PENNSYLVANIA
TEXAS - MARYLAND - UTAH - CANADA